

PRODUCT TITLE

22.3g PREFORM

DRAWING NUMBER

E2064-P-02 ...

ISSUE NUMBER

3

MATERIAL

PET

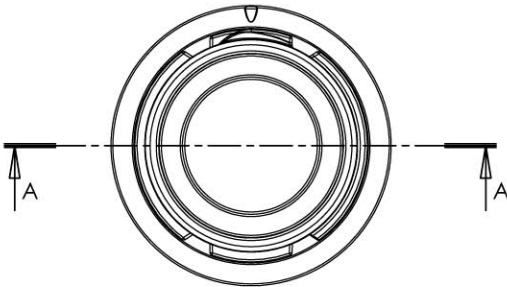
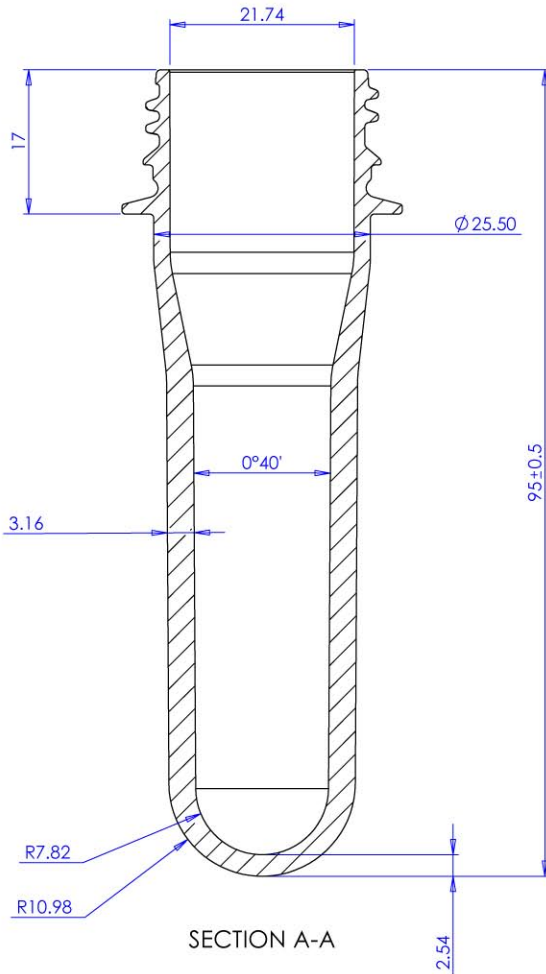

CAPACITY @ FILL LEVEL
@ 20°C after 72hrs

...

CAPACITY @ BRIMFUL
@ 20°C after 72hrs

...

NECK FINISH

28mm PCO 1881

NECK DRAWING No

E1272-N-01

DESIGN WEIGHT

22.3g

ALTERNATIVE WEIGHTS

...

TOOLING REF

694882

DIMENSIONS

ALL DIMENSIONS IN MILLIMETERS UNLESS OTHERWISE STATED

ALL DIMENSIONS SHOWN ARE A REPRESENTATION AND ARE SUBJECT TO CHANGE

UNLESS STATED GENERAL TOLERANCES FOR BLOWN PARTS = ±0.5 mm

UNLESS STATED GENERAL TOLERANCES FOR INJECTED PARTS = ±0.2mm

HEAD OFFICE

ESTERFORM PACKAGING LIMITED
BORASTON LANE
TENBURY WELLS
WORCESTERSHIRE
WR15 8LE, UK

Phone : +44 (0) 1584 810 600
Fax : +44 (0) 1584 810 213

THIS DRAWING AND THE COPYRIGHT THEREON ARE THE PROPERTY OF ESTERFORM LTD AND MUST NOT BE REPRODUCED IN PART OR IN WHOLE OR PASSED ON TO OTHERS WITHOUT PERMISSION